



USER MANUAL

MODEL DM286

Imaging Multimeter

with IGM™ and METERLiNK™

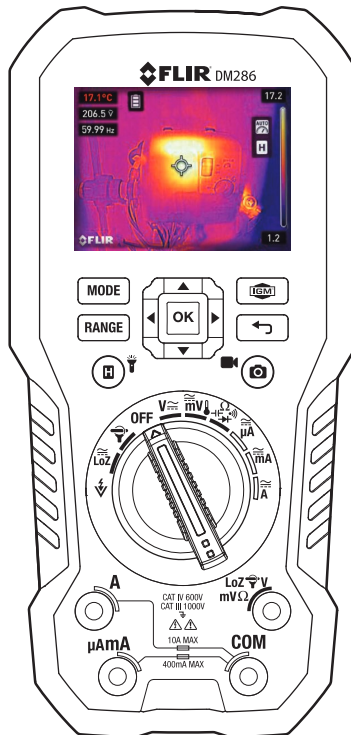

Table of Contents

1. ADVISORIES	5
1.1 Copyright	5
1.2 Quality Assurance	5
1.3 Documentation	5
1.4 Disposal of Electronic Waste	5
2. SAFETY	6
3. INTRODUCTION	8
3.1 Key Features	8
4. METER DESCRIPTION AND REFERENCE	9
4.1 Meter Description	9
4.2 Function Switch Positions	10
4.3 Function Buttons and Navigation Pad	11
4.3.1 MODE Button Operation	11
4.3.2 OK Button/Navigation Pad Operation	12
4.4 Display Icons	12
5. METER POWER	13
5.1 Powering the Meter	13
5.2 Auto Power OFF (APO)	13
6. MENU SYSTEM	14
6.1 Navigating Menus	14
6.2 Advanced Menu	14
7. GENERAL SETTINGS MENU	15
7.1 Settings Menu Navigation	15
7.2 Settings Menu Options	16
7.2.1 Measurement Parameters Menu	16
7.2.1.1 Emissivity Setting	16
7.2.1.2 Reflected Temperature Setting	17
7.2.1.3 Atmospheric Temperature Menu	17
7.2.2 Save Options Menu	17
7.2.3 Device Settings Menu	18
7.2.3.1 Language setting	18
7.2.3.2 Date and Time settings	19
7.2.3.3 Date format	19
7.2.3.4 Temperature Units	20
7.2.3.5 Auto Power Off (APO) Settings	21
7.2.3.6 Bluetooth Enable/Disable	21
7.2.3.7 Screen Brightness Setting	22

7.2.3.8 Log Sampling Rate Setting	22
7.2.4 Information Menu	22
7.2.4.1 System Information	22
7.2.4.2 Reset Options	23
8. THERMAL IMAGING	24
8.1 Thermal Imager Basics	24
8.2 Thermal Imager Operation	26
8.2.1 Laser Pointer and Crosshair Targeting Notes	26
8.3 Thermal Settings Menu	27
8.4 Image Mode Menu	27
8.5 Image and Video Capture	28
8.6 Image and Video Gallery	28
8.7 Share Images and Video with METERLiNK	28
8.8 Share Images and Video with a PC	29
8.9 Temperature Scale	29
8.10 Colour Palette Selections	30
8.11 Data Hold in IGM Mode	30
8.12 Using the Multimeter in the IGM mode	30
9. MULTIMETER OPERATION	31
9.1 Auto/Manual Range Mode	31
9.2 Probe Connection Alert	31
9.3 Out of Range Warning (OL)	31
9.4 Data Hold in MultiMeter Mode	32
9.5 Menu Icons	32
9.6 VFD (Low Pass Filter)	32
9.7 MAX-MIN-AVG mode	33
9.8 Peak Mode	33
9.9 Relative mode	33
9.10 Voltage and Frequency Measurements	34
9.11 Non-Contact Voltage Detector	35
9.12 Resistance Measurements	36
9.13 Continuity Test	37
9.14 Diode Test	38
9.15 Capacitance Measurements	39
9.16 Type K Temperature Measurements	40

9.17 Current and Frequency Measurements (A, mA, μ A)	40
9.17.1 Test Lead Current Measurements (A, mA, and μ A)	41
9.17.2 FLEX Clamp Adaptor Current and Frequency Measurements	43
10. DATA LOGGER	44
10.1 Start Data Logging	44
10.2 Stop Data Logging	44
10.3 View Data Log Files	44
10.4 Delete Data Log Files	44
10.5 Share Data Log Files with METERLiNK	44
10.6 Share Data Log Files with a PC	45
11. METERLINK DATA TRANSMISSION	46
12. APPENDICES	47
12.1 Emissivity Factors for Common Materials	47
12.2 Non-Uniformity Correction	47
13. MAINTENANCE	48
13.1 Cleaning and Storage	48
13.2 Battery Replacement	48
13.3 Fuse Replacement	48
13.4 Disposal of Electronic Waste	48
14. SPECIFICATIONS	49
14.1 General specifications	49
14.2 Thermal MSX Imaging Specifications	50
14.3 Digital Camera Specifications	50
14.4 Electrical Specifications	51
15. CUSTOMER SUPPORT	57
16. WARRANTY	58

1. Advisories

1.1 Copyright

© 2023, FLIR Systems, Inc. All rights reserved worldwide. No parts of the software including source code may be reproduced, transmitted, transcribed, or translated into any language or computer language in any form or by any means, electronic, magnetic, optical, manual, or otherwise, without the prior written permission of FLIR Systems.

The documentation must not, in whole or part, be copied, photocopied, reproduced, translated, or transmitted to any electronic medium or machine-readable form without prior consent, in writing, from FLIR Systems.

Names and marks appearing on the products herein are either registered trademarks or trademarks of FLIR Systems and/or its subsidiaries. All other trademarks, trade names or company names referenced herein are used for identification only and are the property of their respective owners.

1.2 Quality Assurance

The Quality Management System under which these products are developed and manufactured has been certified in accordance with the ISO 9001 standard.

FLIR Systems is committed to a policy of continuous development; therefore, we reserve the right to make changes and improvements on any of the products without prior notice.

1.3 Documentation

To access the latest manuals and notifications, go to the Download tab at: <https://support.flir.com>. It only takes a few minutes to register online. In the download area you will also find the latest releases of manuals for our other products, as well as manuals for our historical and obsolete products.

1.4 Disposal of Electronic Waste



As with most electronic products, this equipment must be disposed of in an environmentally friendly way, and in accordance with existing regulations for electronic waste.

Please contact your FLIR Systems representative for more details.

2. Safety

Safety Notes

- Before operating the device, you must read, understand, and follow all instructions, dangers, warnings, cautions, and notes.
- FLIR Systems reserves the right to discontinue models, parts or accessories, and other items, or to change specifications at any time without prior notice.
- Remove the batteries if the device is not to be used for an extended period.



Warning Statements

- Do not operate the device if you do not have the correct knowledge. Incorrect operation of the device can cause damage, shock, injury, or death to persons.
- Do not start a measuring procedure before you have set the function switch to the correct position. Failure to do so can cause damage to the instrument and can cause injury to persons.
- Before each use, verify tester operation by measuring a known voltage.
- Do not change to the resistance mode when measuring voltage. This can cause damage to the instrument and can cause injury to persons.
- Do not measure the current on a circuit when the voltage increases to more than 1000 V. This can cause damage to the instrument and can cause injury to persons.
- Do not make 10A current measurements for longer than 10 seconds at a time; further, allow a buffer of 15 minutes between each measurement. 10A current measurements which exceed 10 seconds may cause damage to the meter and/or test leads.
- You must disconnect the test leads from the circuit under test before you change the range. Failure to observe this warning can damage the instrument and cause bodily injury.
- Do not replace the batteries before you remove the test leads. This can cause damage to the instrument and can cause injury to persons.
- Do not use the device if the test leads and/or the device show signs of damage. Injury to persons can occur.
- If the insulation on a probe (test lead) is damaged, replace with a new one that meets or exceeds the IEC 61010-031 standard.
- Be careful performing measurements if the voltages are > 25 VAC rms or 35 VDC. There is a risk of shock from these voltages. Injury to persons can occur.
- Do not do diode, resistance, or continuity tests before you have removed the power from capacitors and other devices under test. Injury to persons can occur.
- Be careful when performing voltage checks on electrical outlets. These checks are difficult because of the uncertainty of the connection to the recessed electrical contacts. You must not rely solely on this device when determining if the terminals are not “live”. There is a risk of electrical shock. Injury to person can occur.
- Do not touch expired/damaged batteries without gloves. Injury to persons can occur.
- Do not cause a short circuit of the batteries. This can cause damage to the instrument and can cause injury to persons.

- Do not put the batteries into a fire. Injury to persons can occur.
- Use extreme caution when the laser pointer is on.
- Do not point the beam toward anyone's eye or allow the beam to strike the eye from a reflective surface.
- Do not use the laser near explosive gases or in other potentially explosive areas.
- Refer to the safety statements below for critical safety information.

WARNING
TO AVOID ELECTRICAL SHOCK, REMOVE TEST LEADS
BEFORE OPENING CASE OR BATTERY DOOR.

AVERTISSEMENT
POUR ÉVITER LES ÉLECTROCUTIONS RETIREZ LES FILS D'ESSAI
AVANT D'OUVRIER LE BOÎTIER OU LE COMPARTIMENT À PILES.

CLASS 1 CONSUMER LASER PRODUCT





- FLIR TA04 (3.7V Rechargeable)
- ⊖ FS1 11A 1KV FAST
- ⊖ FS2 600mA 1KV FAST





METER LINK
IOS[®] | Android

DESIGNED & ENGINEERED BY
TELEDYNE FLIR, TAIWAN
10F., No.57, Zhouzi St., NeiHu
District, Taipei City, 114, Taiwan

Model number: DM286
Contains FCC ID: SH6MDBT50Q
Contains IC: 8017A-MDBT50Q



IEC 60825-1: 2014 EN 50689: 2021
Complies with 21 CFR 1040.10 and 1040.11
except for conformance with IEC 60825-1
Ed. 3., as described in Laser Notice No. 56,
dated May 8, 2019

Cautions

Do not use the device in a manner not specified by the manufacturer. This can cause damage to the protection provided.

	This symbol, adjacent to another symbol or terminal, indicates that the user must refer to the user manual for further information.
	This symbol, adjacent to a terminal, indicates that, under normal use, hazardous voltages may be present.
	Double insulation.

3. Introduction

Thank you for selecting the FLIR DM286 True RMS Digital MultiMeter with IGM (Infrared Guide Measurement) and METERLiNK. The DM286 can measure voltage up to 1000V AC/DC and includes Low-Z (low impedance) and VFD (low pass filter) modes. This device is shipped fully tested and calibrated and, with proper use, will provide years of reliable service.

3.1 Key Features

- 6000-count 7.1 cm (2.8 in.) digital TFT display
- Built-in IGM Infrared imager (120 x 160 pixels) with laser pointer and crosshair targeting
- Capture fully radiometric thermal images
- Bluetooth METERLiNK connectivity for sharing images, video, and data log files with mobile devices
- Measures Voltage, Current (A, mA, μ A), Frequency, Resistance/Continuity, Diode, Capacitance, and Temperature
- Built-in non-contact voltage detector (NCV)
- Customizable via easy-to-use menu system
- Data logger stores up to 40,000 readings
- Gallery mode for displaying stored images/video and data log files
- Automatic and Manual ranging
- Input over-voltage warning
- MIN-MAX-AVG memory
- PEAK MIN and PEAK MAX AC V and AC mV measurements
- Flex Clamp direct input
- On-screen programming menu navigation
- Variable-frequency drive VFD mode (low-pass filter)
- Low-Z (low impedance) mode
- Relative mode
- Data Hold
- Auto Power OFF for meter and worklight separately
- Safety Category Rating: CAT IV-600V, CAT III-1000V.
- Equipped with two TA04 rechargeable batteries, CAT IV-600V test leads, CAT IV-600V alligator clips, Type-K thermocouple (-30 to 260°C [-22 to 500°F]) with adapter, USB cable, storage pouch, warranty card, and Quick Start booklet.

4. Meter Description and Reference

4.1 Meter Description

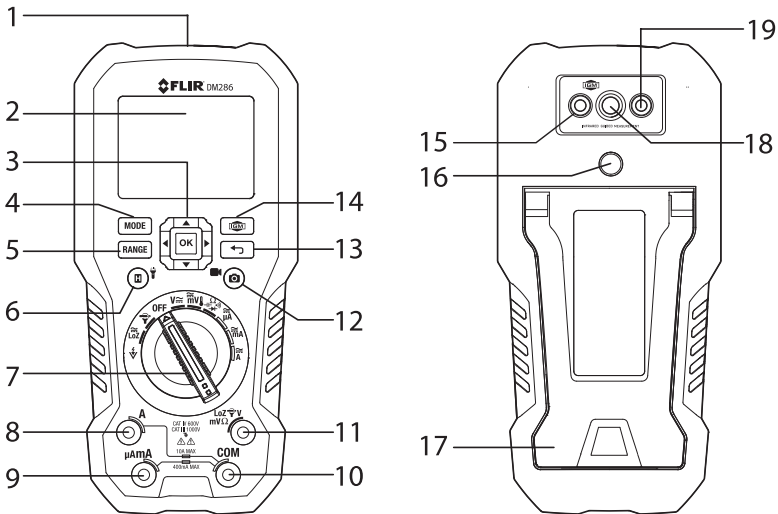



















Fig. 4.1 Meter Description

1. Worklight and NCV detector area
2. LCD Display
3. Navigation/OK buttons
4. MODE button
5. RANGE button
6. Data Hold/Worklight button
7. Rotary Function switch. The switch border is color-coded to match the test lead input jacks
8. Positive (+) Probe Input for **A** (Current)
9. Positive (+) Probe Input for **µA/mA** (Current)
10. COM (-) Probe Input
11. Positive (+) Probe Input for all inputs except **A** and **µA/mA**
12. Image/Video capture button
13. Cancel/Return button
14. IGM (Thermal Imager) button
15. Digital Camera lens
16. Tripod mount
17. Tilt Stand/Battery compartment
18. Thermal Imaging lens
19. Laser pointer lens







4.2 Function Switch Positions

	<p>Detect AC voltage through the non-contact sensor at the top of the meter.</p>
	<p>Measure voltage through the probe inputs with a low-impedance load positioned across the inputs that stabilizes the measurement.</p>
	<p>FLEX Direct: Auxiliary channel for use with optional Flexible Current clamp or standard clamp adaptors when > 600A measurements are required. In this mode, the meter will display true rms ACA measurements from the connected device. Frequency (Hz) can be displayed by pressing the MODE button.</p>
<p>OFF</p>	<p>Meter is switched OFF and in full power-saving mode.</p>
	<p>Measure AC or DC voltage (V) through the probe inputs. Use the MODE button to select or AC, Frequency, or DC.</p>
	<p>Measure low voltage (mV) through the probe inputs. Use the MODE button to select AC or DC voltage.</p>
	<p>Measure temperature with a thermocouple through the probe inputs using a thermocouple adaptor (supplied).</p>
	<p>Measure resistance, continuity, capacitance, or diode through the probe inputs. Use the MODE button to select the desired function.</p>
	<p>Measure µA current through the probe inputs. Use the MODE button to select AC or DC.</p>
	<p>Measure mA current through the probe inputs. Use the MODE button to select AC or DC.</p>
	<p>Measure A current through the probe inputs. Use the MODE button to select AC or DC.</p>

4.3 Function Buttons and Navigation Pad

	Use to select a sub-function of the primary function. See Section 4.3.1, MODE Button Operation , for details.
	From Auto range mode, short press to select Manual range mode. From Manual range mode, short press to change the range (scale). Long press to return to the Auto range mode. Not available for all functions.
	Short press to enable/disable the Thermal Imager.
	OK button with arrow keypad allows you to confirm settings, navigate the menu system, and otherwise control the features and functions.
	Press to exit modes or to return from a menu screen (no function in normal mode).
	Short press to enter/exit the Data Hold mode. In Data Hold mode the displayed reading is suspended (the 'H' icon will be visible). Long press to enable/disable the worklight.
	Short press to capture a fully radiometric thermal image or DMM screenshot. Long press to start a video recording, short press to stop recording. Images/Video are saved to the device's file system accessible in Gallery mode. The thermal imager must be fully initialized (indicated by display of IR temperature measurement) before radiometric data can be captured.

4.3.1 MODE Button Operation

Rotary Switch Position and Description		Sequence of operations
	Non-contact voltage detector	No operation
	Low impedance	AC > Frequency > DC
	Clamp adaptor	No operation
	AC/DC Voltage	AC > Frequency > DC
	Milli-volts / Temperature	AC > Frequency > DC > °C/°F
	Resistance / Continuity / Diode / Capacitance	Resistance > Continuity > Diode > Capacitance
	AC/DC current	AC <> DC

4.3.2 OK Button/Navigation Pad Operation

There are five (5) buttons arranged in a square that make up the Navigation pad, as shown in Figure 4-2.

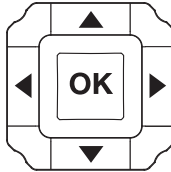

Fig. 4.2 Navigation Pad

OK button (center) Access the main menu and select/change menu options

LEFT/RIGHT buttons: Navigate the menu system

UP/DOWN buttons: Navigate the menu system and amend settings

4.4 Display Icons

	FLEX Clamp		Data Logger
	Laser pointer		Data Hold
	Relative mode		Auto Range
	Continuity mode		Sensed voltage > 30 V
	Diode mode		Non-contact Voltage Detector (NCV)
	Low pass filter		MAX, MIN, AVG readings
	Low impedance mode		Peak MAX/MIN readings
	Worklight		Emissivity
	Bluetooth		AC signal
	Auto Power Off		DC signal
	Battery Status		

Note: The table above provides a list of the most often displayed icons. Other icons are shown and explained in the sections of the manual where they apply.

5. Meter Power

5.1 Powering the Meter

The meter is powered by the supplied TA04 rechargeable battery. Two are provided, so you can charge one while the other is in use. The battery is inserted in the rear battery compartment. The compartment is behind the tilt stand, secured by a rotating lock. Use a screwdriver or a coin to lock and unlock the compartment.



Fig. 5.1 Battery Compartment Lock

Move the function switch from the OFF position to switch the meter on. If the battery indicator  shows that the battery voltage is low, if a low battery screen appears (Fig. 5.2), or if the meter does not power on, replace the TA04 battery with a fully charged one. See [Section 13.2, Battery Replacement](#).

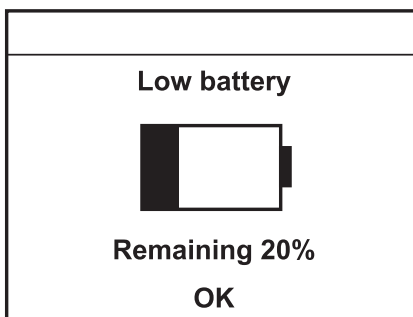

Fig. 5.2 Low Battery Alert

5.2 Auto Power OFF (APO)

The DM286 has separate APO settings for the meter and worklight. The APO time for each is selected in the Settings menu (refer to [Section 7.2.3.5](#)).

Set the meter APO to OFF, 2, 5, or 10 minutes.

Set the worklight APO to OFF, 5, 15, or 30 minutes.

6. Menu System

6.1 Navigating Menus

- Press **OK** to open the Main Menu, shown below:



Fig. 6.1 Main Menu

- Use the **Navigation Pad** left/right arrows to highlight an icon.
- Each icon is briefly defined in **Fig. 6.2**, below, with complete information provided in the Sections referenced.









	Image Mode Menu (Section 8.4). Available only when the thermal imager is open.
	Thermal Settings Menu (Section 8.3 , <i>Thermal Settings Menu</i>). Available only when the thermal imager is open.
	Image, Video, and Data Log Gallery (Sections 8.5 and 8.6)
	Advanced Menu (Section 6.2)
	Settings Menu (Section 7)

Fig. 6.2 Main Menu Icons

- Press **OK** to open a menu or to set an option ON or OFF. When an option is ON a blue dot appears next to its icon. In some cases, use the navigation arrows to select an option.
- Use the Return  button to exit menu levels and to return to the normal display mode.
- Icons are grayed-out when they are not available in a particular mode.

6.2 Advanced Menu

Press **OK** at the Advanced Functions menu icon  to access the functions listed below. Highlight a function using the arrow buttons and then press **OK** to activate it. Refer to the dedicated section for each as listed below for detailed information:

 MAX-MIN-AVG Readings, see [Section 9.7, MAX-MIN-AVG mode](#)

 Peak mode, see [Section 9.8, Peak mode](#)



 Relative mode, see [Section 9.9, Relative mode](#)

 Data logger, see [Section 10, Data logger](#)

7. General Settings Menu

7.1 Settings Menu Navigation

Under Settings, the user can customize a variety of features.

1. Press **OK** to open the Main Menu.
2. Scroll to the Settings  icon and press **OK** to open the Settings menu.
3. Use the arrow buttons to scroll the options and press **OK** on a menu item to open it.
4. Use the  button to exit screens and to return to the normal mode.
5. A menu overview is presented in **Fig. 7.1** below. Detailed instructions are provided in the sections that follow.

Measurement parameters >	Set Emissivity	Set Reflected temp.	Set Atmospheric temp.
Save option >	Select YES to save a digital image with each thermal image.		
Device settings (below)			
Language	Select desired display language.		
Date and Time	Set calendar clock.		
Date Format	Set year, month, and day format and 12/24 clock mode.		
Temperature units	Set degrees C/F.		
Auto Power Off (APO)	Set meter and worklight APO time.		
Bluetooth	Set ON/OFF.		
Screen Brightness	Set low, medium, or high.		
Log Sampling Rate	Data logger capture rate (1 to 100 seconds).		
Information (below)			
System Information	View model and serial number, software/firmware versions, battery status (% power), and more.		
Reset options	Revert to factory default settings/Format internal memory.		

Fig. 7.1 Settings Menu Overview

7.2 Settings Menu Options

There are four options available when you open the Settings menu, as shown in **Fig. 7.2** below, Measurement Parameters, Save Options, Device Settings, and Information.

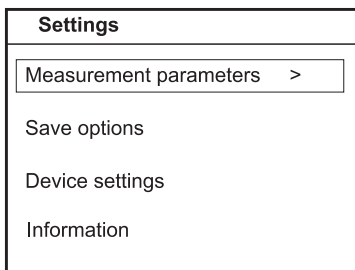

Fig. 7.2 Settings Main Menu

7.2.1 Measurement Parameters Menu

In the Measurement Parameters menu, you can select emissivity, reflected temperature, and Atmospheric temperature, as shown below.

7.2.1.1 Emissivity Setting

The screen examples below detail the emissivity setting procedure. Select a preset or set a custom value with the arrow buttons.

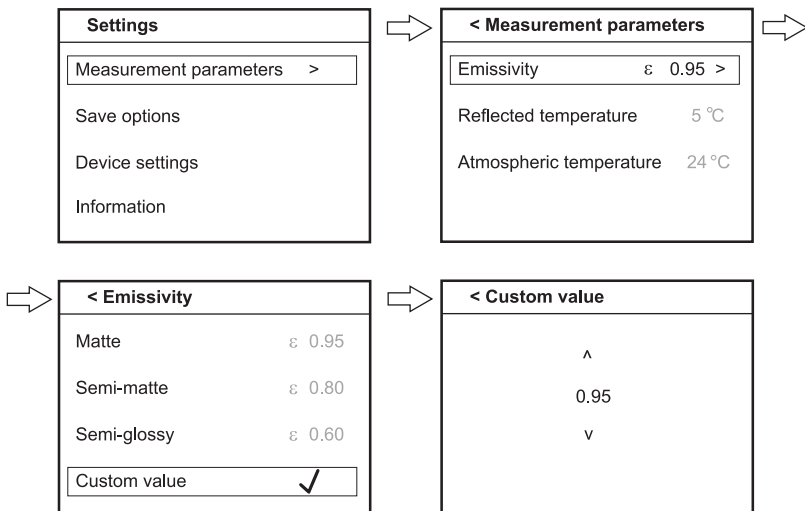

Fig. 7.3 Emissivity Menu

7.2.1.2 Reflected Temperature Setting

Fig. 7.4 below shows the reflected temperature menu. Use the arrow buttons to change the reflected temperature.

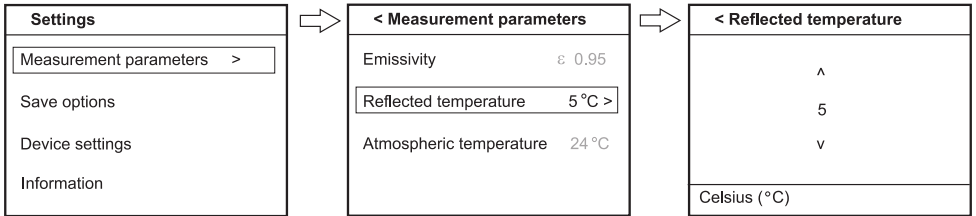

Fig. 7.4 Reflected Temperature Menu

7.2.1.3 Atmospheric Temperature Menu

Fig. 7.5 below shows the atmospheric temperature menu. Use the arrow buttons to change the atmospheric temperature.

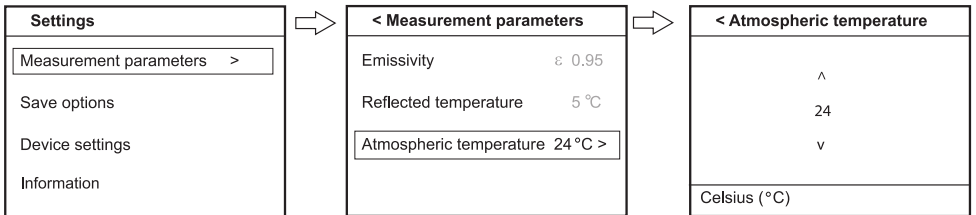

Fig. 7.5 Atmospheric Temperature Menu

7.2.2 Save Options Menu

In the Save Options menu, select ON, to save a .jpg digital camera image along with every thermal image you capture.

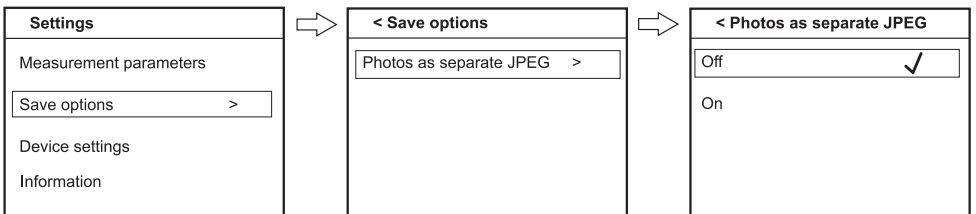

Fig. 7.6 Save Options Menu

7.2.3 Device Settings Menu

Fig. 7.7 below shows the Device Settings main menu.

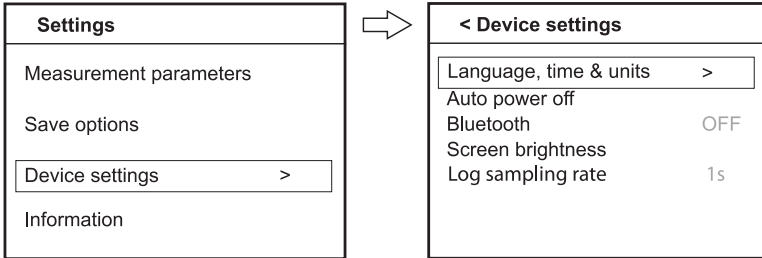

Fig. 7.7 Device Settings Main Menu

Scroll the menu using the arrow buttons and press OK on an option to open it. In the sub-menus, the arrows are used to scroll and to change settings. Use the Return button to back out of menus. The following sections explain each Device Setting option.

7.2.3.1 Language setting

As shown in Fig. 7.8 below, use the up/down arrows to select a language setting and use the OK button to confirm.

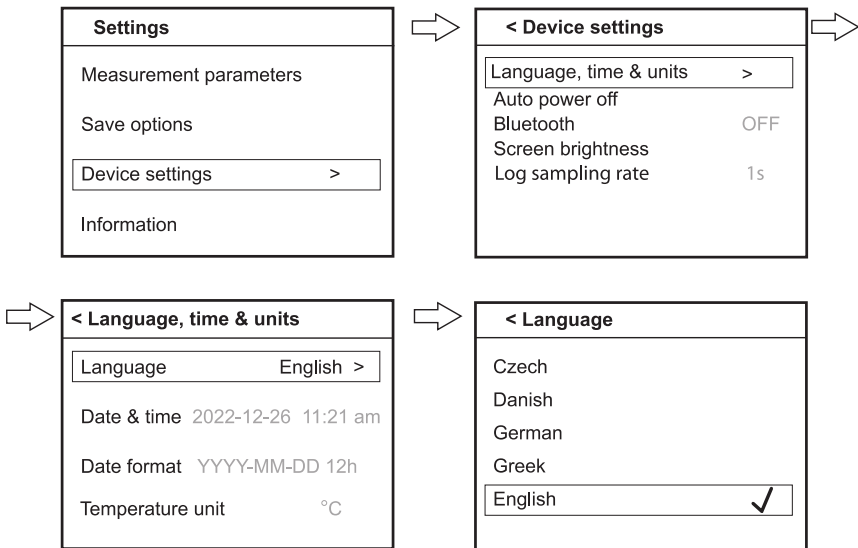

Fig. 7.8 Language Selection

7.2.3.2 Date and Time settings

As shown in **Fig. 7.9** below, use the left/arrows to move from field to field. Use the up/down arrows to change settings.

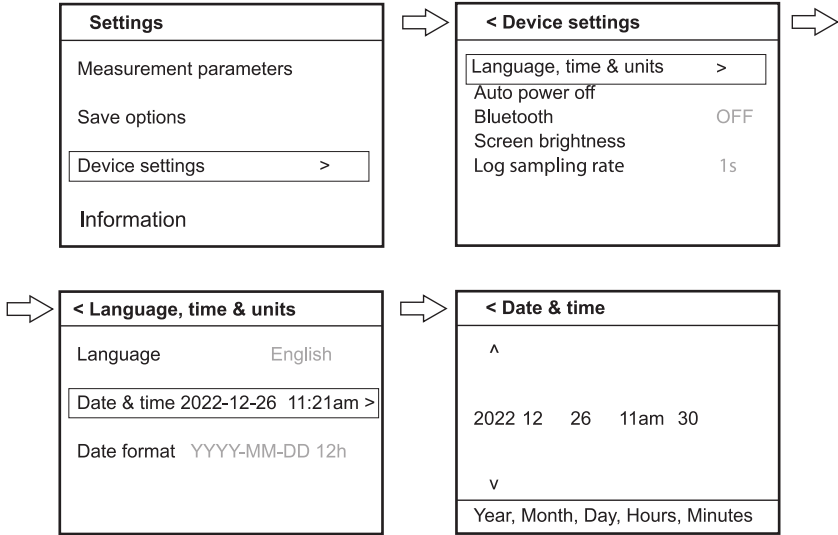

Fig. 7.9 Date and Time Settings

7.2.3.3 Date format

As shown in **Fig. 7.10** below, use the left/arrows to move from field to field. Use the up/down arrows to change settings.

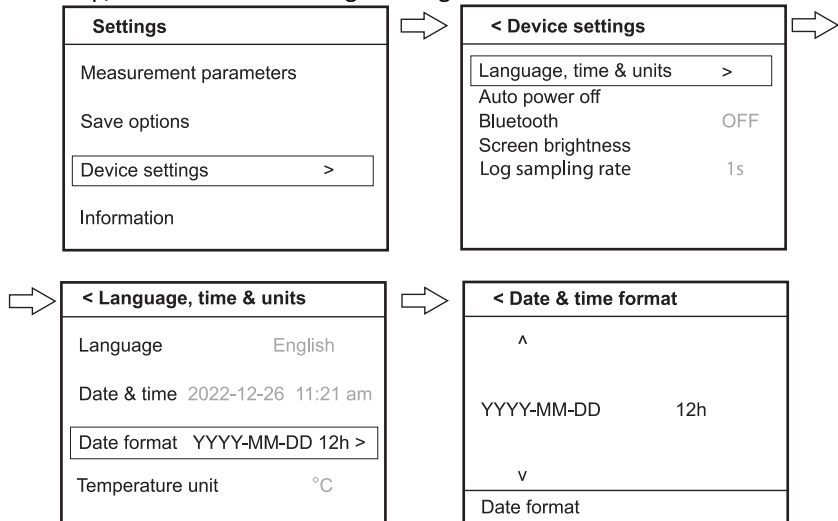

Fig. 7.10 Date Format Settings

7.2.3.4 Temperature Units

As shown in **Fig. 7.11** below, select the desired temperature units C/F.

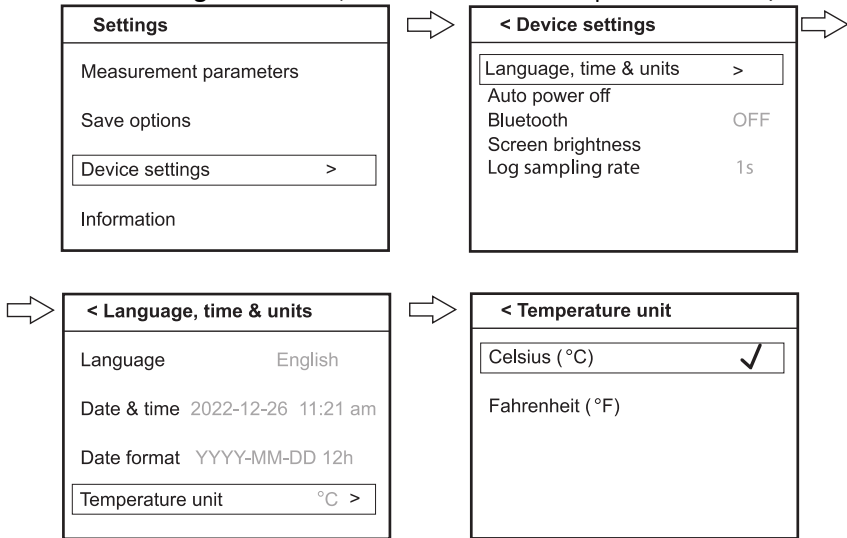



Fig. 7.11 Temperature Units selection

7.2.3.5 Auto Power Off (APO) Settings

In this menu, you can set the APO for the device (meter) and for the worklight separately. As shown in **Fig. 7.12**, below, scroll to Device or Worklight and press OK. At the next screen use the arrow buttons to select a time (or select OFF to disable the APO utility).

When the device APO is enabled, the screen shows the icon . Only the device APO is shown in **Fig 7.12**; worklight APO options are OFF, 5, 15, or 30 minutes.

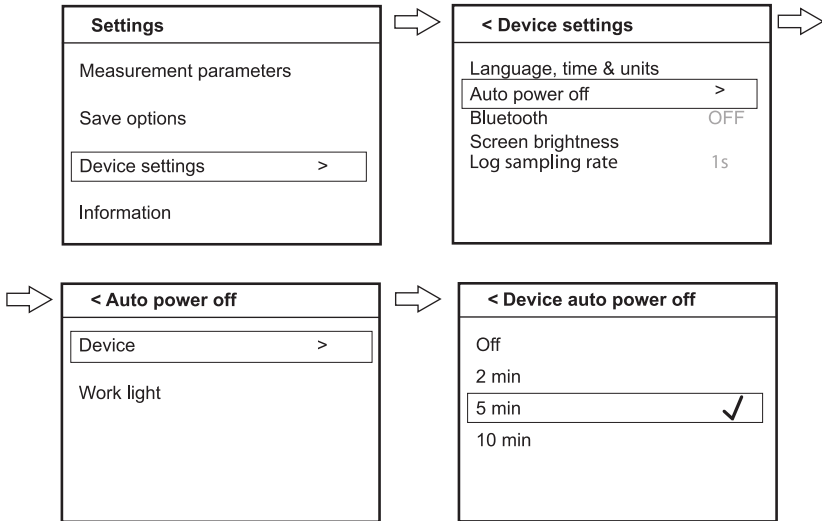

Fig. 7.12 Setting Auto Power Off Timer

7.2.3.6 Bluetooth Enable/Disable

As shown in **Fig. 7.13** below, scroll to ON or OFF and press OK to enable or disable Bluetooth communication. For complete information refer to [Section 11](#).

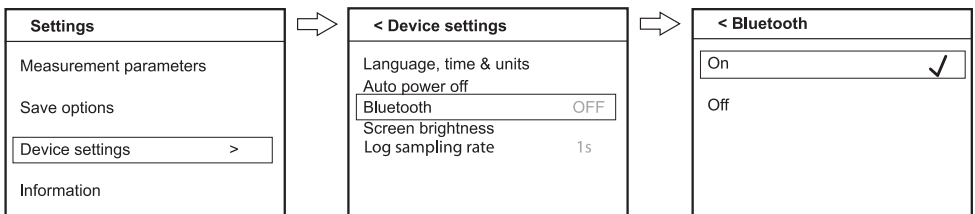

Fig. 7.13 Bluetooth Enable/Disable

7.2.3.7 Screen Brightness Setting

As shown in **Fig. 7.14**, below, scroll to the desired brightness level and press OK to confirm.

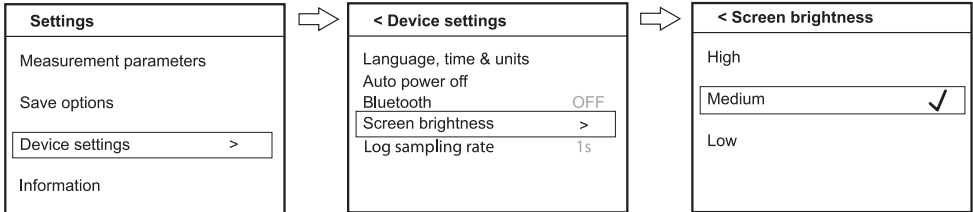

Fig. 7.14 Screen Brightness Setting

7.2.3.8 Log Sampling Rate Setting

As shown in **Fig. 7.15**, below, scroll to the desired rate at which the meter will log readings (from 1 to 100 seconds) and press **OK** to confirm.

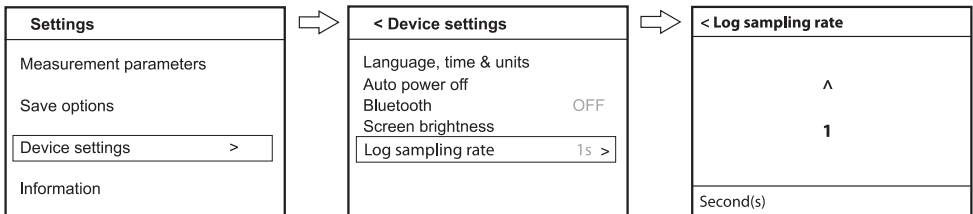

Fig. 7.15 Set Data Logger Sampling Rate

7.2.4 Information Menu

In the Information Menu you can review system information and revert the meter settings to their factory default settings.

7.2.4.1 System Information

As shown in **Fig. 7.16**, below, view the meter’s system information: model and serial numbers, software/firmware/Bluetooth versions, available internal memory, and battery power level (%).

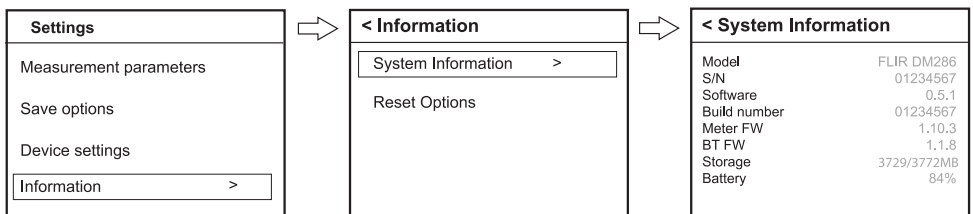

Fig. 7.16 System Information

7.2.4.2 Reset Options

In the Reset Options menu, you can revert settings to their factory default state and/or format the meter's internal memory drive.

As shown in **Fig. 7.17**, below, navigate to the desired reset option and press **OK**. You will be prompted to proceed or cancel the operation. Note that on the prompt screen, when an option's text is blue, the option is selected for action, press **OK** to complete the action. Use the arrow buttons to toggle the text color. Select Cancel to abort the action.

When resetting to factory default, all camera and language settings will be affected. Saved images, video, and data logs will not be affected.

When you format the meter's internal memory, all images, video, and data logs will be erased. Download data before initializing the meter's internal memory.

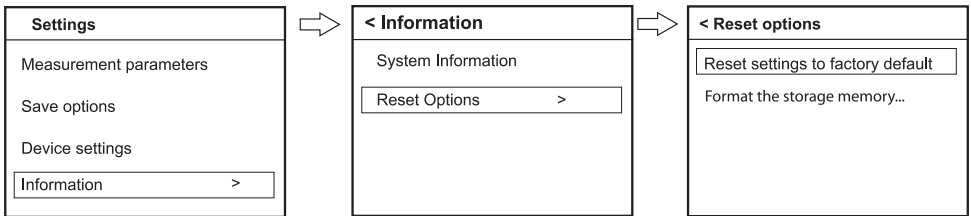

Fig. 7.17 Reset Options Menu

8. Thermal Imaging

8.1 Thermal Imager Basics

In the Thermal Imaging mode, the user can measure the temperature of targeted surfaces. Colour differences in the image reflect temperature variations in the targeted area. The laser pointer and display crosshairs assist in targeting.

Press the IGM button to open the Thermal Imager. The hourglass icon will appear while the imager is initializing (**Fig. 8.1**). If the meter switches off during initialization, this is because battery power is too low to support thermal imaging; recharge the battery before continuing.

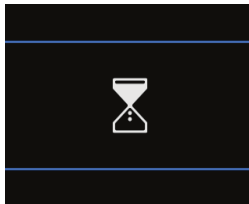

Fig. 8.1 Thermal imager initialization screen

In **Fig 8-2**, below, the meter is set to colour palette IRON. Select other palettes in the Thermal Settings Menu (refer to [Section 8.3, Thermal Settings Menu](#)).

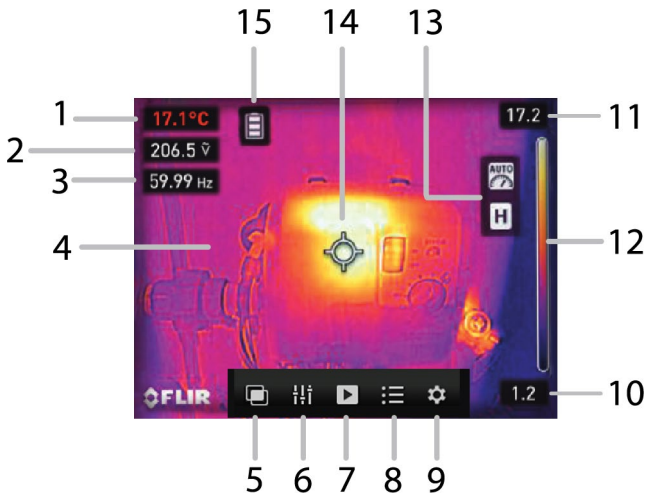

Fig. 8.2 Thermal Image Example

1. IR Temperature measurement represents the temperature of the spot sensed. Note that while the imager initializes, the measurement digits are preceded by the approximation symbol (~), indicating that full accuracy has not yet been reached.
2. MultiMeter voltage measurement
3. MultiMeter frequency measurement
4. Thermal image (160 x 120 pixels)
5. Image mode menu
6. Thermal settings menu
7. Image, video, and data log gallery
8. Advanced menu
9. General settings menu
10. Low end of the temperature scale for the image
11. High end of the temperature scale for the image
12. Entire colour range of the image
13. Auto Range (top) and Data Hold (bottom) icons
14. Crosshairs for targeting
15. Battery status icon (see [Section 4.4, Display Icons](#) for more icons)

8.2 Thermal Imager Operation

To customize the Thermal Imager, refer to [Section 8.3, Thermal Settings Menu](#). For basic operation, follow these steps:

1. Set the function switch to any position.
2. Press the **IGM** button to switch the Thermal Imager ON. Point the thermal imaging lens (back of meter) toward an area to test.
3. The display will show the temperature in the upper left-hand corner of the targeted area.
4. In the Thermal Imaging mode, use the laser pointer and display crosshairs for targeting. These can be switched ON or OFF in [Section 8.3, Thermal Settings Menu](#).
5. In the Thermal Imaging mode, the meter continues to operate normally as a MultiMeter, view electrical measurements and functions on the upper left side of the display (below the temperature measurement).
6. The thermal imager's resolution is 120 x 160 pixels and its FOV (Field of View) is 57 degrees (horizontal) by 44 degrees (vertical) see **Fig. 8.3**.

8.2.1 Laser Pointer and Crosshair Targeting Notes

1. The laser pointer and crosshairs converge accurately on a target when the meter is within 1 m (3.3 ft.) of the target. As you move further away, a parallax error is introduced, and the laser pointer becomes slightly less accurate. In these cases, rely on the crosshairs for targeting, as they are accurate, regardless of distance.
2. Measurements made in bright light can obscure the laser pointer. Always rely on the crosshairs for the most accurate targeting.

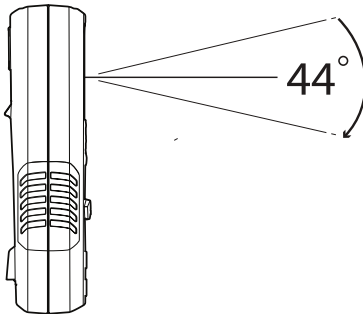

Fig. 8.3 (a) Field of View – Vertical

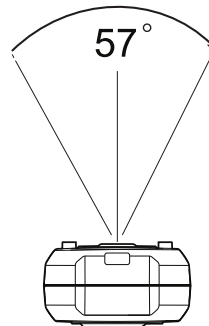



Fig. 8.3 (b) Field of View - Horizontal

8.3 Thermal Settings Menu

1. Press **OK** to open the main menu
2. Scroll to the Thermal Settings icon  and press **OK**
3. Refer to **Fig. 8.4** below for menu options











Icon	Description	Operation
	Colour Palette	Press OK to step through the colour palettes (iron, rainbow, arctic, white hot, and black hot). Refer to Section 8.10 for examples.
	Measurement mode	Select  to measure a surface using crosshairs targeting. Select  or  to automatically target the warmest or coldest spot. Select  to remove multimeter measurements from the thermal image.
	Temperature scale	Select AUTO to use the full thermal range or select LOCK to limit the thermal region. See Section 8.9 for more information.
	Laser pointer	Press OK to toggle the laser pointer ON (blue circle) or OFF
	Emissivity	Press OK to open the emissivity menu and select a preset or a custom setting as shown in Section 7 .

Fig. 8.4 Thermal Settings Menu

8.4 Image Mode Menu

The Image Mode menu  has four options (**Fig. 8.5**). The *Alignment Distance* and *Thermal MSX* options pertain to MSX® (Multi-Spectral Dynamic Imaging), where the digital camera adds visible light details to the thermal image, for clarity.





Icon	Description	Operation
	Alignment Distance	Press OK on this icon to begin aligning the MSX image. Use the left/right arrows to adjust the horizontal alignment.
	Thermal MSX	Press OK on this icon to view the MSX image.
	Thermal camera	Press OK on this icon to view the thermal image only.
	Digital camera	Press OK on this icon to view the digital camera image only.

Fig. 8.5 Image Mode Menu

8.5 Image and Video Capture

Short press  to save a thermal image. Long press to start recording video; short press to stop recording. Up to 30k images can be stored in the meter's 4 GB internal memory. Videos up to 50 minutes in length can be recorded.







Saved thermal images are fully radiometric (each pixel includes temperature measurement data). To view radiometric data within captured thermal images, send the images to a mobile device using the METERLiNK app.

Note that the imager must be fully initialized before radiometric data can be captured. Allow several minutes after powering the meter before taking readings.

From the meter you can view, share, and delete images and video as explained below.

8.6 Image and Video Gallery

Follow the steps below to view and process images and video.

1. Press **OK** to open the Main Menu.
2. Press **OK** at the Gallery  icon.
3. Press **OK** on the Images/Video menu.
4. Use the left/right arrow buttons to scroll to an image or video.
5. Press **OK** to open a selected image or video. Press **OK** again to open a menu that offers the following actions:
 -  View full screen (images only) or start video playback
 -  Share media with mobile devices ([Section 11](#))
 -  View image name, date, and time
 -  Permanently remove image or video
6. Press the Return button  to exit.

8.7 Share Images and Video with METERLiNK

Share images with a mobile device running the METERLiNK app. Refer to [Section 11](#) for more information.

1. With an image opened, press **OK**.
2. Scroll to the Share icon  and press **OK** to begin transmitting the image.

Note that videos > 30 seconds in length cannot be transmitted. Videos approximately 30 seconds in length will require 3 to 4 minutes transmission time.

8.8 Share Images and Video with a PC

Connect the meter to the PC using the supplied USB cable. The USB connector is behind the battery in the battery compartment. The USB connection powers the meter.

When successfully communicating with a PC the USB symbol appears (**Fig. 8.6**). Once the PC recognizes the meter as an external storage drive you can offload video and images by dragging them out of the DM286 drive.

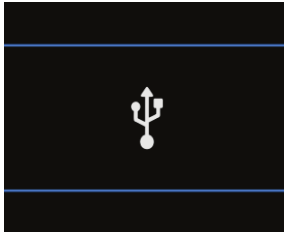

Fig. 8.6 USB Connection Status

Note: For best results, use the supplied USB cable to connect to the meter. If using another cable, ensure that the cable molding at the connection end is < 11.5 x 6 mm, otherwise it will not fit in the meter connection opening.

8.9 Temperature Scale

Navigate to the Temperature Scale icon in the Thermal Settings menu ([Section 8.3](#)) and press **OK**. Use the navigation buttons to select **Auto** (where the camera uses the entire thermal range), or **Lock** (where you can freeze the range to a narrow thermal region).

In **Fig. 8.7**, below, the image on left shows the Auto mode where the temperature range uses all the available spectrum. The image on right shows the Lock mode where the temperature range is constrained. To constrain the range, point to a spot in the frame that represents the temperature of interest, and then select the Lock mode.

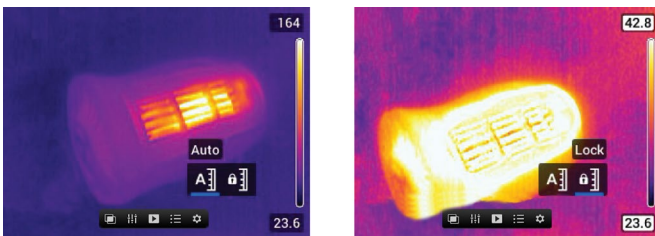

Fig. 8.7 AUTO (left) and LOCK (right) Temperature Scales

8.10 Colour Palette Selections

The colour palettes are selected in the Thermal Settings menu ([Section 8.3](#)). Colour palette examples are shown in **Fig. 8.8**, below. Each image below shows the colour scheme and its range bar graph on the right.

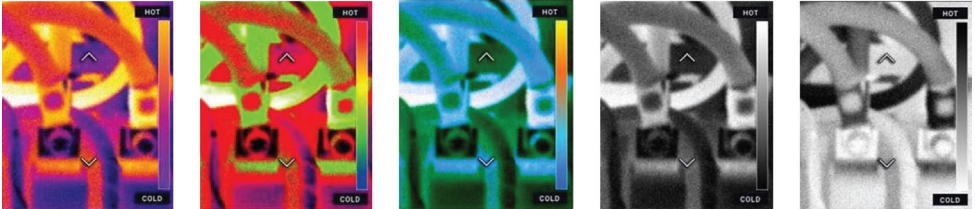

Fig. 8.8 Iron, Rainbow, Arctic, White Hot, and Black Hot (L to R) colour palettes

8.11 Data Hold in IGM Mode

In Data Hold mode, the multimeter readings are frozen. To enter/exit Data Hold mode, press the **H** (hold) button. In Hold mode, the **H** indicator appears.

8.12 Using the Multimeter in the IGM mode

The Multimeter can be used as described in [Section 9, Multimeter Operation](#) while viewing thermal images. Multimeter readings, status bar icons, and operational modes can be viewed directly on top of the thermal image.

9. MultiMeter Operation

Caution: Before operating the device, you must read, understand, and follow all instructions, dangers, warnings, cautions, and notes.





Caution: When the meter is not in use, the function switch should be set to the OFF position.

Caution: When connecting the probe leads to the device under test, connect the COM (negative) lead before connecting the positive lead. When removing the probe leads, remove the positive lead before removing the COM (negative) lead.

9.1 Auto/Manual Range Mode

In Auto range mode, the meter automatically selects the most appropriate measurement scale. In Manual range mode, the desired range (scale) can be adjusted by the user.

Auto range mode is the default mode of operation. When a new function is selected with the function switch, the starting mode is Auto range and the indicator  is displayed.

1. To enter Manual range mode, short press the  button. To change the range, press the  button repeatedly until the desired range is displayed.
2. To return to the Auto range mode, long press the  button until the Auto Range  indicator is again displayed.

9.2 Probe Connection Alert

For voltage or current measurements, with the tests leads incorrectly connected to the meter (or not connected at all), an error screen will appear (**Fig. 9.1**).





Fig. 9.1 Test lead connection error screens

9.3 Out of Range Warning (OL)

If the input is over/under the full-scale range in Manual range mode, or if the signal has exceeded the maximum/minimum input in Auto range mode, 'OL' is displayed.

9.4 Data Hold in MultiMeter Mode

In Data Hold mode, for all measurement modes except thermocouple mode, the primary display digits are held. In thermocouple mode, the temperature reading in both °F and °C are held. To enter/exit Data Hold mode, short press the  (hold) button. In Hold mode, the  indicator is displayed.

9.5 Menu Icons

Menu icons displayed in the IGM mode are explained in [Section 8](#).

There are 5 main options in the Menu bar. See [Section 6, Menu System](#).









	Image Mode Menu (Section 8.4). Available only when the thermal imager is open.
	Thermal Settings Menu (Section 8.3 , <i>Thermal Settings Menu</i>). Available only when the thermal imager is open.
	Image, Video, and Data Log Gallery (Sections 8.5 and 8.6)
	Advanced Menu (Section 6.2)
	Settings Menu (Section 7)

Fig. 9.2 Menu icons

- Use the Left / Right buttons to move the cursor.
- Press the **OK** button to select an option.
- If an option is disabled (grayed) it is not available in the currently active mode.





9.6 VFD (Low Pass Filter)

VFD eliminates high-frequency noise from AC current and voltage measurements using a low-pass filter.

Long press the **MODE** button to add/remove the low pass filter to the measurement, the VFD icon  will appear in this mode.



9.7 MAX-MIN-AVG mode

Access MAX-MIN-AVG mode  through the Advanced Menu; see [Section 6.2, Advanced Functions menu](#). Press **OK** on this icon to begin recording and viewing the highest, lowest, and average readings.

1. A blue dot appears next to the icon when you select this mode.
2. The highest reading will be shown next to the MAX icon 
3. The lowest reading will be shown next to the MIN icon 
4. The average reading will be shown next to the AVG icon 
5. Press **OK** at this icon  in the Advanced Menu to exit this mode.

9.8 Peak Mode

Access Peak mode  through the Advanced Menu; see [Section 6.2, Advanced Functions menu](#). In Peak mode, the meter captures and displays the positive and negative **V** or **mV AC** peak values. The Peak display values change only when higher/lower values are registered.

1. Press **OK** to show the Peak Max  and Peak Min  readings on the display.
2. Press **OK** to switch this mode OFF.

9.9 Relative mode

Access Relative mode  through the Advanced Menu; see [Section 6.2, Advanced Functions menu](#). Press **OK** on this icon to capture a reference reading which to compare subsequent measurements.

1. A blue dot appears next to the icon when you select this mode.
2. The reference value will be displayed next to the Relative icon.
3. The primary display will show the difference between the measured value and the stored reference.
4. Press **OK** at this icon to switch the Relative mode OFF.

9.10 Voltage and Frequency Measurements

1. Set the function switch to one of the following positions. See **Fig. 9.3**.
 - V_{\sim} For high voltage measurements
 - mV (milli-volts) for low voltage measurements.
 - **LoZ** for voltage measurements using the meter's low input impedance mode. The **LoZ** indicator will be displayed.
2. Insert the black probe lead into the negative COM terminal and the red probe lead into the positive terminal.
3. Use the **MODE** button to select AC or DC measurements:
 - The \sim indicator will be displayed for AC measurements.
 - The --- indicator will be displayed for DC measurements.
4. Connect the probe leads in parallel to the part under test.
5. Read the voltage value on the display.
6. The Frequency (Hz) of the measured voltage is shown on the smaller, secondary display digits above the primary voltage reading. Press the **MODE** button to view only the Frequency reading.

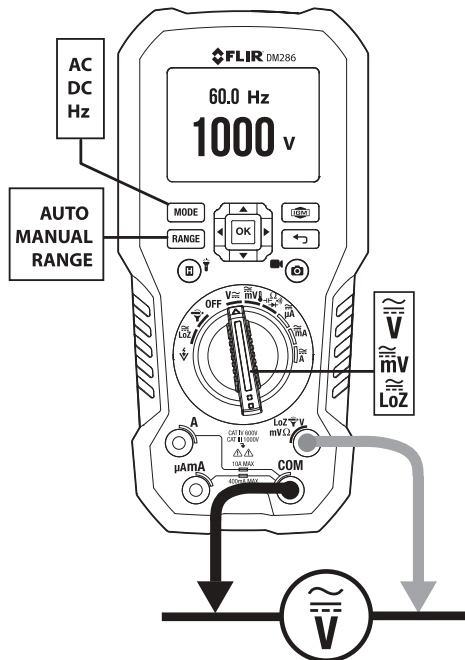



Fig. 9.3 Voltage and Frequency Measurements

9.11 Non-Contact Voltage Detector

1. Set the function switch to the NCV  position. See Fig. 9.4.
2. Be sure to remove the test leads from the meter when doing NCV tests.
3. Position the top of the meter close to a source of voltage or electromagnetic field.
4. When the meter detects a voltage or electromagnetic field it emits a continuous tone and the displayed NCV icon will turn red in colour, flash, and include horizontal bars indicating the strength of the signal (the more bars, the higher the voltage) as shown here .

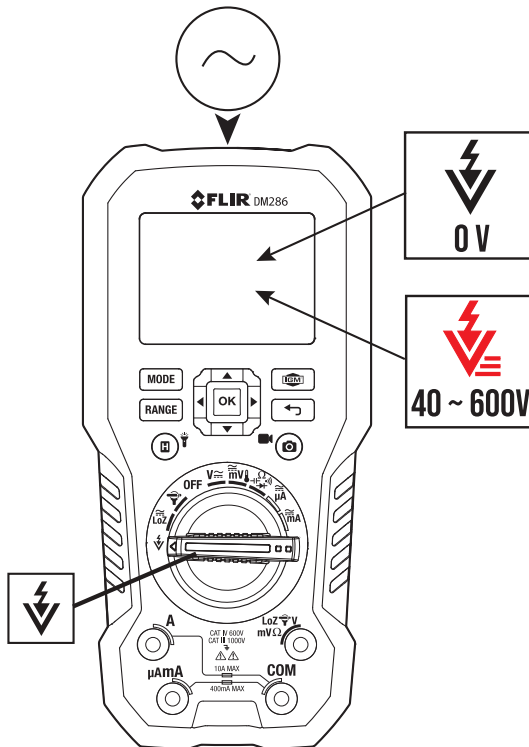

Fig. 9.4 Non-Contact Voltage Detector

9.12 Resistance Measurements

Warning: Do not perform diode, resistance, or continuity tests before removing power from capacitors and other devices under test during a measurement. Injury to persons can occur.

1. Refer to **Fig. 9.5**. Set the function switch to the Ω position.
2. Use **MODE** to step to the Ω display if necessary.
3. Insert the black probe lead into the negative COM terminal and the red probe lead into the positive Ω terminal.
4. Touch the tips of the probe across the circuit or component under test.
5. Read the resistance value on the display.

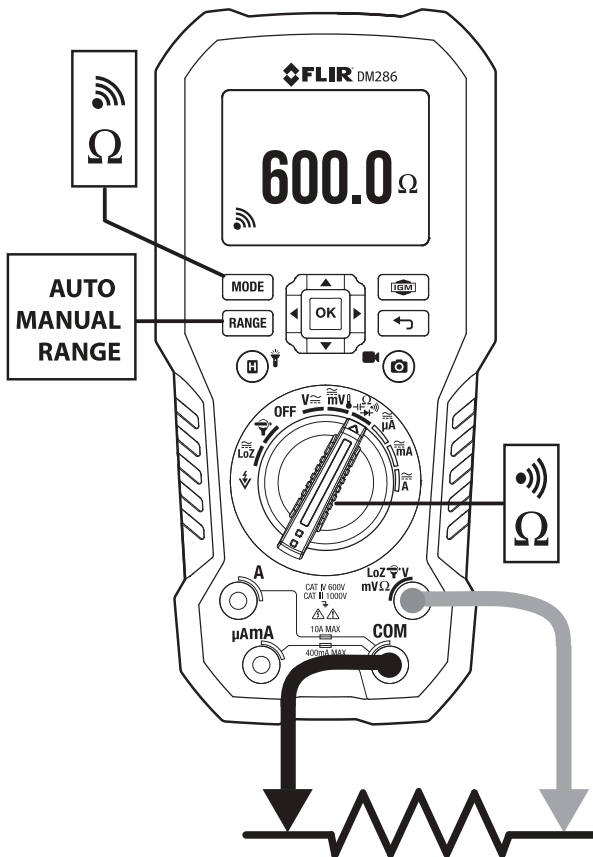



Fig. 9.5 Resistance and Continuity Measurements



9.13 Continuity Test

Warning: Do not perform diode, resistance, or continuity tests before removing the power from capacitors and other devices under test during a measurement. Injury to persons can occur.

1. Refer to **Fig. 9.5**. Set the function switch to the  position.
2. Use the **MODE** button to select continuity. The  indicator will be displayed.
3. Insert the black probe lead into the negative COM terminal and the red probe lead into the positive terminal.
4. Touch the tips of the probe across the circuit or component under test.
5. If the resistance is $< 10 \Omega$ the meter beeps. If the resistance is $> 100 \Omega$ the meter will not beep. $> 10 \Omega$ but $< 100\Omega$ the beeping will stop at an unspecified point.

9.14 Diode Test

Warning: Do not perform diode tests before removing the power to the diode or other devices under test during a measurement. Injury to persons can occur.

1. Set the function switch to the diode  position. Use the MODE button to select the diode test function. The diode indicator  will be displayed.
2. Insert the black probe lead into the negative COM terminal and the red probe lead into the positive terminal.
3. As shown in **Fig. 9.6**, touch the tips of the test leads across the diode in one direction (1) and note the voltage reading. Touch the tips of the test leads across the diode in the opposition direction (2) and note that reading.
4. To determine if the diode is good or bad, use the voltage reading combinations shown in **Fig. 9.6** as a guide.

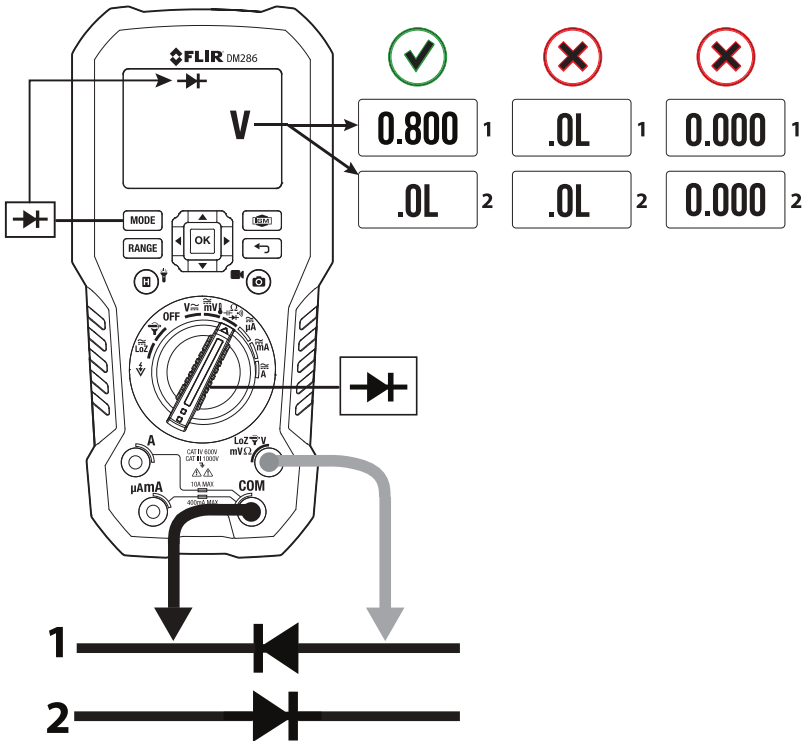

Fig. 9.6 Diode Test

9.15 Capacitance Measurements

Warning: Do not perform capacitance tests before removing power to the capacitor or other devices under test during a measurement. Injury to persons can occur.

1. Set the function switch to the $\rightarrow|-\leftarrow$ position. See **Fig. 9.7**.
2. Use the **MODE** button to select the capacitance measurement. The F (Farad) unit of measure will be displayed.
3. Insert the black probe lead into the negative COM terminal and the red probe lead into the positive terminal.
4. Touch the tips of the probe across the part under test.
5. Read the capacitance value on the display.

Note: For very large capacitance values, it may take several minutes for the measurement to settle and the final reading to stabilize.

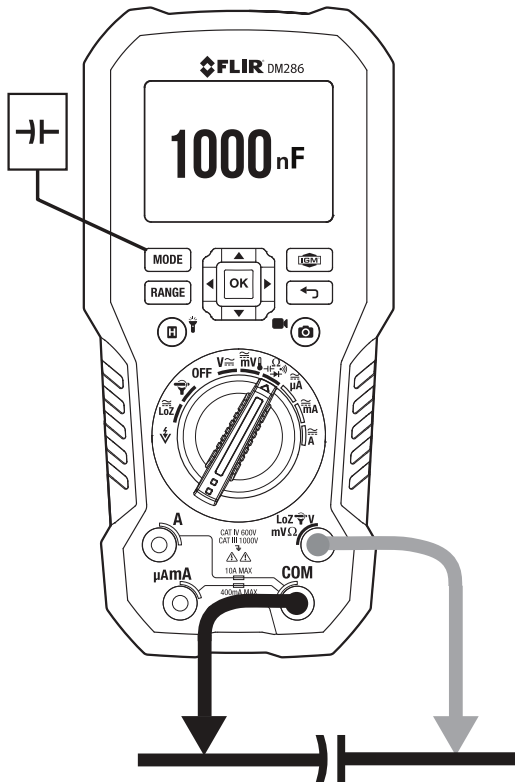

Fig. 9.7 Capacitance Measurements

9.16 Type K Temperature Measurements

1. Set the function to the Temperature K position. See **Fig. 9.8**.
2. Use the **(MODE)** button to select temperature measurement. The $^{\circ}\text{F}$ and $^{\circ}\text{C}$ units will be displayed. To make one unit of measure the primary unit, use the General Settings menu ([Section 7, General Settings](#)).
3. While observing the polarity, insert the thermocouple adapter into the negative COM terminal and the positive terminal.
4. Touch the tip of the thermocouple to the part under test. Keep the thermocouple tip on the part until the reading stabilizes.
5. Read the temperature value on the display.
6. To avoid electrical shock, disconnect the thermocouple adapter before turning the function switch to another position.

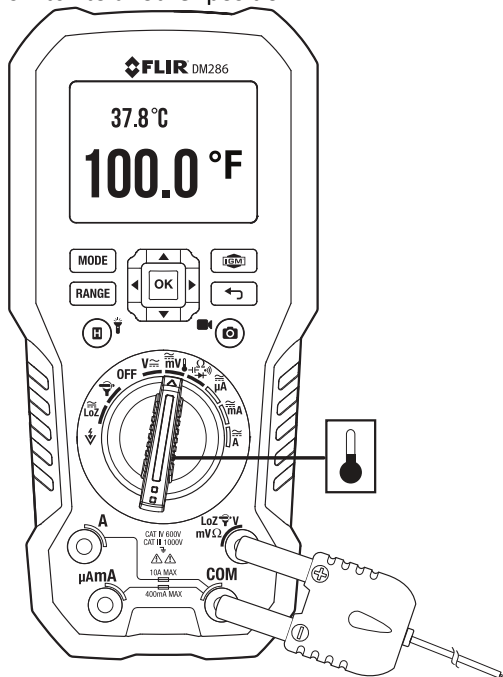

Fig. 9.8 Temperature Measurements

9.17 Current and Frequency Measurements (A, mA, μA)

For test lead current measurements, disconnect the part under test and connect the test leads in series with the part, see **Fig. 9.9**.



Fig. 9.9 Disconnected component

9.17.1 Test Lead Current Measurements (A, mA, and μA)

1. For test lead measurements (A, mA, and μA), set the function switch to the $\tilde{\text{A}}$, $\tilde{\text{mA}}$ or $\tilde{\mu\text{A}}$ position.
2. Insert the black probe lead into the negative COM terminal and the red probe lead into one of the following positive terminals:
 - **A** for high current measurements.
 - **mA** for lower current measurements.
 - **μA** for micro-amp measurements
3. Use the **MODE** button to select AC or DC measurement.
 - The \sim indicator will be displayed for AC measurements.
 - The --- indicator will be displayed for DC measurements.
4. Connect the probe leads in series with the part in accordance with **Fig. 9.10** for 'A' measurements, **Fig. 9.11** for mA measurements, or **Fig. 9.12** for μA measurements.
5. Read the current and frequency values on the display.

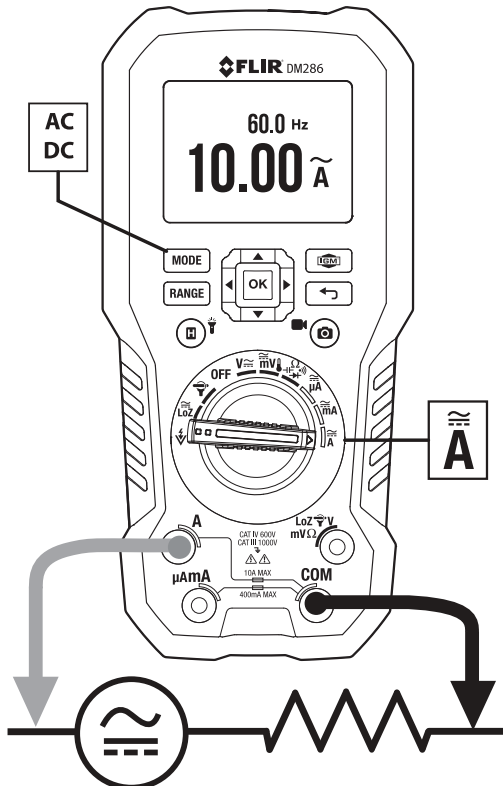

Fig. 9.10 High Current 'A' Measurements

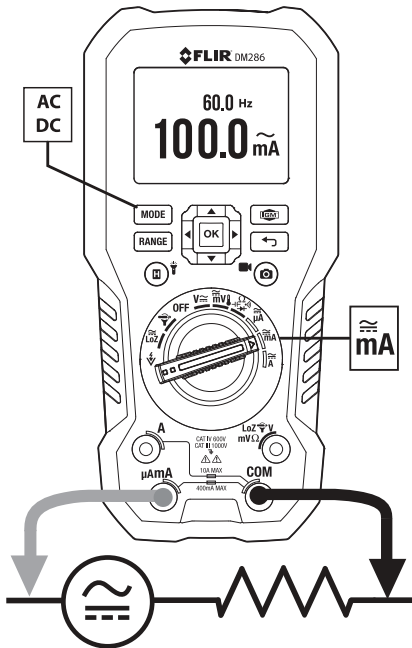

Fig. 9.11 mA Current Measurements

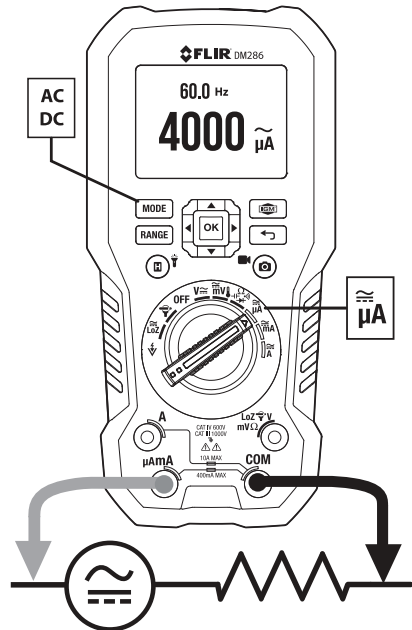



Fig. 9.12 μA Current Measurements

9.17.2 FLEX Clamp Adaptor Current and Frequency Measurements

FLIR Flex Clamp Adaptors (Models TA72 and TA74, for example) and other clamp adaptors connect to the DM286 to display current measurements made by a clamp adaptor.

1. Turn the function dial to the  position.
2. Connect a Clamp adaptor as shown in **Fig. 9.13**.
3. Set the Range of the Flex Clamp Adaptor to match the range of the DM286.
4. Use the RANGE button to select the range of the DM286 (1, 10, 100 mV/A). The selected range appears on the top of the DM286 display.
5. Operate the Flex Clamp per instructions provided with the Flex Clamp meter.
6. Read the current measured by the Flex Clamp on the DM286 LCD. The frequency also appears on the DM286 secondary display.

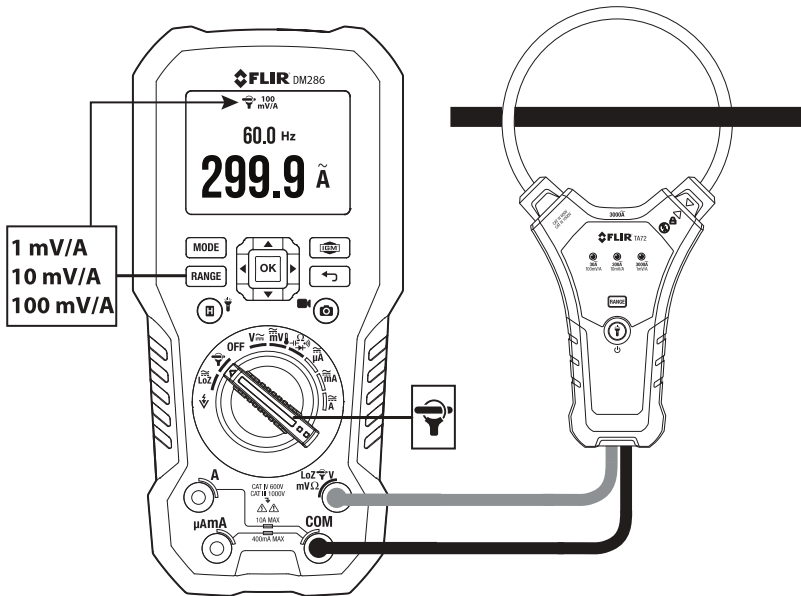





Fig. 9.13 FLEX Clamp Adaptor Application



10. Data Logger

The meter can log up to 40,000 readings. Each time the logger is started, a new log file is created, and the previous one is archived. Data log files can be viewed, transmitted, saved to PC, or deleted, directly through the meter interface.

10.1 Start Data Logging

1. Press **OK** to access the main menu.
2. Press **OK** at the Advanced Menu  icon.
3. Press **OK** at the data logger icon  to begin storing readings at the selected sample rate. The sample rate is adjustable from 1 to 100 seconds in the General Settings menu ([Section 7](#)). The data logger display icon  will appear while the logger is running.



10.2 Stop Data Logging

1. Press **OK** to access the main menu.
2. Press **OK** at the Advanced Menu  icon.
3. Press **OK** at the data logger icon  to stop logging. The data logger icon will switch off.

10.3 View Data Log Files

1. Press **OK** to access the Main menu.
2. Press **OK** at the Gallery  icon.
3. Scroll to the Data Logs option and press **OK**.
4. Scroll to a data log file and press **OK** to open it. The list of recorded measurements for the file will appear. Scroll data using the arrow buttons.

10.4 Delete Data Log Files

1. With a data log file open, press **OK**. Three icons will appear on the bottom of the display, data transmit , delete , and data information .
2. Scroll to the trash icon and press **OK** to delete all readings in the selected file.

10.5 Share Data Log Files with METERLiNK

Transmit data log files to a mobile device running the METERLiNK app. Refer to [Section 11](#) for more information.

1. With a data log file open, press **OK**.
2. Scroll to the transmission icon  and press **OK** to begin transmitting all the readings in the selected file.

10.6 Share Data Log Files with a PC

1. Connect the meter to a PC with the supplied USB cable. The USB connector is located behind the battery, in the battery compartment. The USB connection powers the meter, so the battery is not needed in this process.
2. Once the PC recognizes the meter as an external storage drive, you can offload data log files by dragging them out of the DM286 drive directory.
3. When the data log files are downloaded to your PC you can open them in a spreadsheet or other program that can open text files (*.csv). An example data log file, opened in a spreadsheet, is shown in **Fig. 10.1**, below.

Device model	Function Name	Function index	Unit Name	Unit index	OL Max	OL Min	Sampling Rate	Sampling Unit (second)
FLIR DM286 (09-000017)	Resistance	0x15	Ohm	0x04	999999	0.999999	1	1
NO	DATE	TIME	VALUE	POWER OF 10	UNIT	OUT OF RANGE		
	0	1/17/2023	14:38:35	100.1	0	Ohm		
	1	1/17/2023	14:38:36	100.1	0	Ohm		
	2	1/17/2023	14:38:37	100.2	0	Ohm		
	3	1/17/2023	14:38:38	100.2	0	Ohm		
	4	1/17/2023	14:38:39	100.1	0	Ohm		



Fig. 10.1 Data log file opened in a spreadsheet

11. METERLiNK Data Transmission

The DM286 can share saved images, video, and data log files with a mobile device running the **METERLiNK** application, available from the App Store® for iOS devices, and Google Play™ for Android devices. Videos longer than 30 seconds in length cannot be transmitted; videos approaching 30 seconds can take up to 4 minutes to fully transmit.

Mobile devices running METERLiNK can locate and pair with the DM286. Bluetooth must be enabled on both devices for successful communication. See [Section 7](#) for instructions on enabling Bluetooth on the DM286. The Bluetooth icon  appears on the DM286 when Bluetooth is enabled.

To transmit data from the DM286, follow these steps.

1. Press **OK** to access the DM286 main menu
2. Navigate to the Gallery icon  and press **OK**
3. Navigate to **Data Log or Images and Video** and press **OK**
4. Navigate to the media that you wish to transmit and press **OK** to open it
5. Press **OK** again on the opened image, video, or data log file; a series of option icons will appear
6. Navigate to the ‘share’ icon  and press **OK** to transmit the file

To control the DM286 from the app, please refer to the separate METERLiNK user manual and the help screens available from within the app. An example screen is shown in **Fig. 11.1**, below.

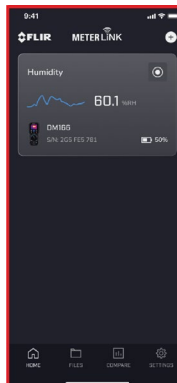

Fig. 11.1 Example METERLiNK Mobile Application Screen

For more information related to image and video capturing and processing, refer to [Sections 8.5 and 8.6](#). For information regarding data logging, refer to [Section 10](#).

12. Appendices

12.1 Emissivity Factors for Common Materials

Material	Emissivity	Material	Emissivity
Asphalt	0.90 to 0.98	Cloth (black)	0.98
Concrete	0.94	Skin (human)	0.98
Cement	0.96	Leather	0.75 to 0.80
Sand	0.90	Charcoal (powder)	0.96
Soil	0.92 to 0.96	Lacquer	0.80 to 0.95
Water	0.92 to 0.96	Lacquer (matt)	0.97
Ice	0.96 to 0.98	Rubber (black)	0.94
Snow	0.83	Plastic	0.85 to 0.95
Glass	0.90 to 0.95	Timber	0.90
Ceramic	0.90 to 0.94	Paper	0.70 to 0.94
Marble	0.94	Chromium Oxides	0.81
Plaster	0.80 to 0.90	Copper Oxides	0.78
Mortar	0.89 to 0.91	Iron Oxides	0.78 to 0.82
Brick	0.93 to 0.96	Textiles	0.90

12.2 Non-Uniformity Correction

A non-uniformity correction (or NUC) is an image correction carried out by the camera software to compensate for different sensitivities of detector elements and other optical and geometrical disturbances¹.

The NUC is an automatic function that takes place periodically (approximately every 2-3 minutes) or whenever the inner core of the camera detects a $\pm 2^{\circ}\text{C}$ temperature change. The term *calibrating...* will appear at the top of the display while this correction is active.

1. Definition from the imminent international adoption of DIN 54190-3 (Non-destructive testing – Thermographic testing – Part 3: Terms and definitions).

13. Maintenance

13.1 Cleaning and Storage

Wipe the housing with a damp cloth as needed. Use a high-quality lens wipe to remove dirt or smudges from the meter lenses and display window. Please do not use abrasives or solvents to clean the meter housing, lenses, or display window.

If the meter is not to be used for an extended period, remove the batteries, and store them separately.

13.2 Battery Replacement

The DM286 operates only on FLIR TA04 rechargeable battery packs. The Battery symbol flashes, and a low battery warning appears when the batteries have reached a critical level. The meter displays readings within specifications while the low battery indicator is on. The meter powers off before it displays an out of tolerance reading.

WARNING: To avoid electrical shock, disconnect the meter from any connected circuits, remove the test leads from the meter terminals, and set the function switch to the OFF position before attempting to recharge the batteries.

1. Lift the tilt stand to access the battery compartment.
2. Unlock and remove the battery compartment cover.
3. Replace the TA04 battery pack with a fully charged pack.
4. Secure the battery compartment cover.



Never dispose of used batteries or rechargeable batteries in household waste. As consumers, users are legally required to take used batteries to appropriate collection sites, the retail store where the batteries were purchased, or wherever batteries are sold.

13.3 Fuse Replacement

The two fuses are accessed via the battery compartment.

- mA: 600 mA, 1000 V IR 10 kA fuse (CHNBEL 632.000)
- A: 11 A, 1000 V IR 30 kA fuse (adler APD2110700)

13.4 Disposal of Electronic Waste

As with most electronic products, this equipment must be disposed of in an environmentally friendly way, and in accordance with existing regulations for electronic waste. Please contact your FLIR Systems representative for more details.

14. Specifications

14.1 General specifications

Maximum voltage	1000 V DC or 1000 V AC RMS
Display Counts	6000
Polarity Indication	Automatic, positive implied, negative indicated
Over-range Indication	OL
Measuring Rate	3 samples per second
Bluetooth range	10 m (32 ft.)
Power Requirements	TA04 rechargeable lithium-polymer battery (3.7 V, 3050 mAh)
Battery life	Approx. 6.5 hours in IGM mode with display brightness set to medium Approx. 10 hours in Multimeter mode (medium brightness)
Auto Power Off	For Meter: set to OFF, 2, 5, or 10 minutes For Worklight only: set to OFF, 5, 15, or 30 minutes
Operating Temp/RH	-10°C to 30°C (14°F to 86°F), < 85% RH
	30°C to 40°C (86°F to 104°F), < 75% RH
	40°C to 50°C (104°F to 122°F), <45% RH
Storage Temperature/RH	-20°C to 60°C (-4°F to 140°F), 0-80% RH (without batteries)
Temperature Coefficient	0.1 x (specified accuracy)/°C, < 18°C (64.4°F), >28°C (82.4°F)
Operating Altitude	2000 m (6560 ft.)
Calibration Cycle	One year
Weight	569 g (1.25 lbs.) without battery (approx.)
Dimensions	19.9 x 9.2 x 5.1 cm (7.8 x 3.6 x 2.0 in.)
Safety	Complies with IEC 61010-1 CAT IV-600 V, CAT III-1000V Certifications: ETL, FCC, CE, RCM, UKCA, FDA, EN60825, EN50689 EMC: EN 61326-1; pollution degree: 2 IP40 rated Drop protection: 2m (6.6 ft.)

14.2 Thermal MSX Imaging Specifications

IR temperature measurement range	-5 to 300°C (23 to 572°F) OL is display when range is exceeded
IR measurement stabilization	The approximation symbol (~) is shown next to the temperature reading when the reading accuracy has not yet stabilized (~125°C, for example). The symbol will disappear when the reading is stable. Stabilization typically requires 2 to 3 minutes (at room temperature).
IR temperature resolution	0.1°
Image sensitivity	≤ 150mK (0.15°C)
IR temperature accuracy	± 3°C (5.4°F) or 3% (whichever is greater) for temperatures > 25°C (77°F). ± 5°C (9°F) for temperatures -10 to 25°C (14 to 77°F).
IR image capture frequency	9 Hz
Emissivity	0.10 to 1.00 (default is 0.95); select from four presets or set manually
Response time	150ms
Spectral Response	8 to 14um
Scanning and targeting	Continuous scan. Crosshairs and laser pointer targeting.
Repeatability	0.5%
Image Detector	FLIR Lepton® microbolometer
MSX	Multi-Spectral Imaging (digital camera adds visible light details to the thermal image for clarity)
Field of View (FOV)	160 x 120 pixels (57° x 44°)
Colour Palettes	Iron, rainbow, arctic, white hot, and black hot
Stored thermal image radiometry	Fully radiometric
Laser type	Class 1 red
Laser power	< 0.39mW
Laser wavelength	640 to 660 nm

14.3 Digital Camera Specifications

Digital camera resolution	2 MP (1600 x 1200 pixels)
Focus	Fixed
Field of view	71° x 56°

14.4 Electrical Specifications

Accuracy is given as \pm (% of reading + counts of least significant digit) at $23^{\circ}\text{C} \pm 5^{\circ}\text{C}$, with relative humidity < 80%. Temperature coefficient: $0.1 * (\text{Specified accuracy}) / ^{\circ}\text{C}$, < 18°C , > 28°C

14.4.1 - AC Voltage and Current

Function	Range	Resolution	Accuracy	Input Protection (sine wave)
AC Voltage (V)	600.0mV	0.1 mV	$\pm (1.0\% + 3 \text{ digits})$	1000 V RMS
	6.000V	0.001 V	$\pm (1.0\% + 3d)$	
	60.00V	0.01 V		
	600.0V	0.1 V		
	1000V	1 V		
Low pass filter (VFD) ACV	600.0 mV	0.1 mV	$\pm (1.3\% + 4d)$ 45 to 65Hz -3db at Approx 1.2 kHz	1000 V RMS
	1000V	1 V		
Lo-Z ACV	1000V	1 V	$\pm (1.3\% + 4d)$	1000 V RMS
AC Current (A)	4000uA	1 μA	$\pm (1.5\% + 3d)$	FF 600 mA H 1000 V
	400.0mA	0.1 mA		
	10.00A	0.01 A	$\pm (1.5\% + 3d)$	FF 11 A H 1000 V
Low pass filter (VFD) ACA	4000 μA	1 μA	$\pm (1.3\% + 4d)$ 45 to 65Hz -3db at Approx 1.2 kHz	1000 V RMS
	400.0 mA	0.1 mA		
	10.00 A	0.01 A		
Low pass filter (VFD) ACA – Clamp mode	30.00 A	0.01 A		
	300.0 A	0.1 A		
	3000 A	1 A		

Additional AC Voltage and Current Notes

1. True RMS responding
2. Frequency response (ACV/ACA): 45Hz to 1kHz
3. Input Impedance: $\text{mV} \geq 100\text{M}\Omega$; $\text{ACV} \geq 10\text{M}\Omega$; Lo-Z (low impedance): Approximately $3\text{K}\Omega$
4. Do not measure the current on a circuit when the voltage > 1000 V. This can cause damage to the instrument and can cause injury to persons.

5. Do not make 10A current measurements for longer than 10 seconds at a time; further, allow a buffer of 15 minutes between each measurement. 10A current measurements which exceed 10 seconds may cause damage to the meter and/or test leads.
6. Assurance accuracy range: 5 to 100% of range
7. Residual readings:
 - ACV : ≤ 5 digits (input jacks short circuit)
 - ACA : ≤ 5 digits (input jacks open circuit)
8. AC crest factor can reach 2.5 at 3000 counts. At 6000 counts, crest factor will drop to approx. 3. For non-sinusoidal waveforms, a 2% buffer is added.

14.4.2 - Flexible ACA Clamp Adapter

Function	Range	Resolution	Accuracy	Input Protection (sine wave)
ACA Clamp 	30.00A AC	0.01	$\pm (1.3\% + 5 \text{ digits})$	1000 V RMS
	300.0A AC	0.1		
	3000A AC	1		

Additional Clamp Adapter Notes

1. Frequency response: 45Hz to 400Hz sine wave
2. This mode is the same as an analog voltage input. The specified accuracy represents the accuracy of the DM286 only. The external adapter accuracy is additional, and not reflected in these specs.
3. Frequency sensitivity applies when the input signal exceeds 10% of the measurement range.
4. Voltage/current ratio (measurements start at 30mV; full range AC: 0.030V to 3.30V; signals > 3.3V will display **OL**):
 - 30A range: 100mV (AC) = 1A
 - 300A range: 10mV (AC) = 1A
 - 3000A range: 1mV (AC) = 1A
5. Press the RANGE button to select appropriate voltage/current ratio.

14.4.3 - DC Voltage

Function	Range	Resolution	Accuracy	Input Protection
DC Voltage (V)	600.0mV	0.1mV	$\pm (0.2\% + 3 \text{ digits})$	1000 V
	6.000V	0.001V	$\pm (0.9\% + 3d)$	
	60.00V	0.01V		
	600.0V	0.1V		
	1000V	1V		
Lo-Z DCV	1000V	1 V	$\pm (1.3\% + 4d)$	1000 V

Additional DC Voltage Notes

1. Input Impedance: $mV \geq 100M\Omega$; $DCV \geq 10M\Omega$
2. Assurance accuracy range: 5 to 100% of range
3. Residual readings: ≤ 5 digits (input jacks short circuit)
4. Lo-Z (low impedance): Approximately $3K\Omega$

14.4.4 - DC Current

Function	Range	Resolution	Accuracy	Input Fuse Protection
DC Current (A)	4000 μ A	1 μ A	$\pm (1.0\% + 3 \text{ digits})$	FF 600mA H 1000V
	400.0mA	0.1mA		
	10.00A	0.01A		

Additional DC Current Notes

1. Assurance accuracy range: 5 to 100% of range
2. Do not measure the current on a circuit when the voltage > 1000 V. This can cause damage to the instrument and can cause injury to persons.
3. Do not make 10A current measurements for longer than 10 seconds at a time; further, allow a buffer of 15 minutes between each measurement. 10A current measurements which exceed 10 seconds may cause damage to the meter and/or test leads.

14.4.5 - Resistance

Function	Range	Resolution	Accuracy	Input Protection (sine wave)
Resistance (Ω)	600.0 Ω	0.1 Ω	$\pm (1.3\% + 3 \text{ digits})$	1000 V RMS
	6.000 k Ω	0.001 k Ω	$\pm (0.9\% + 3 \text{ digits})$	
	60.00 k Ω	0.01 k Ω		
	600.0 k Ω	0.1 k Ω	$\pm (0.9\% + 5 \text{ digits})$	
	6.000 M Ω	0.001 M Ω	$\pm (3.0\% + 5 \text{ digits})$	
	60.00 M Ω	0.1 M Ω		

Additional Resistance Notes

1. Measured value = displayed value minus short circuit value
2. Assurance accuracy range: 5 to 100% of range

14.4.6 - Continuity

Function	Symbol	Resolution	Action	Input Protection (sine wave)
Continuity (Ω)		0.1 Ω	$\leq 10 \Omega$ = beeper ON	1000 V RMS
			$\geq 100 \Omega$ = beeper OFF	

Additional Continuity Notes

1. Measurements between 10 and 100 Ω may or may not cause the beeper to sound
2. Current < 1.5 mA

14.4.7 - Diode

Function	Symbol	Resolution	Action	Input Protection (sine wave)
Diode		0.001 V	Silicon PN junction with forward voltage bias = 0.5 to 0.8 V	1000 V RMS

Additional Diode Note

1. Open circuit voltage = 3V approximately.

14.4.8 - Capacitance

Function	Range	Resolution	Accuracy	Input Protection (sine wave)
Capacitance (F)	600.0 nF	0.1 nF	$\pm (2.0\% + 5d)$	1000 V RMS
	6.000 μ F	0.001 μ F		
	60.00 μ F	0.01 μ F		
	600.0 μ F	0.1 μ F	$\pm (4.0\% + 5d)$	
	10.00 mF	0.01 mF		

Additional Capacitance Notes

1. Residual readings: ≤ 10 digits (input jacks open circuit)
2. Measured value = display value minus short circuit value
3. Assurance accuracy range: 5 to 100% of range

14.4.9 - Frequency

Function	Range	Resolution	Accuracy	Input Protection (sine wave)
Frequency (Hz)	10.00 Hz to 100.0 kHz	0.01 Hz to 0.1 kHz	$\pm (0.1\% + 5d)$	1000 V RMS

Additional Frequency Notes

- No manual range functionality
- Accuracy range :
 - AC mV: 10Hz to 100kHz; > 100kHz unspecified
 - ACV, AC LoZ: 10Hz to 10kHz; > 10kHz unspecified
 - Clamp adapter setting: 10Hz to 10kHz; > 10kHz unspecified
- Pulse width > 0.1mS; zero-crossing waveform
- No independent frequency selection for AC V, AC mV, and AC Lo-Z modes; the default frequency is displayed above the main measurement; press MODE button to show frequency as the main measurement.
- Input voltage range :
 - AC mV: $100\text{mV} \leq \text{Input amplitude} \leq 20\text{Vrms}$
 - ACV, AC Lo-Z: $15\text{V} \leq \text{Input amplitude} \leq \text{OL}$
 - Clamp setting: $300\text{mV} \leq \text{Input amplitude} \leq \text{OL}$

14.4.10 - Temperature (Type-K Thermocouple)

Function	Range	Resolution	Accuracy	Input Protection (sine wave)
Temperature (°C)	-40 to 400 °C	1 °C	$\pm (1.0\% + 3d)$	1000 V RMS
Temperature (°F)	-40 to 752 °F	2 °F	$\pm (1.0\% + 5.4d)$	

Additional Temperature Notes

- Ensure correct polarity when connecting the thermocouple to the meter.
- The Lo-Z ACV function mode can heat the meter internally to moderate levels and affect temperature measurements. Allow 10 minutes after using Lo-Z mode before attempting temperature measurements.
- The display will show **OL** with no thermocouple connected.
- The specified accuracy does not include the accuracy of the thermocouple probe.
- Accuracy specification assumes a meter internal temperature of 25°C (77°F). For long measurement sessions, the meter's internal temperature can increase > 25°C thereby widening the specified accuracy for temperature measurements. For best results, switch the meter off and allow it to normalize to room temperature before taking critical temperature measurements.

14.4.11 - Non-Contact Voltage Detection (NCV)

Function	Range	Frequency
NCV 	40 to 600 V	50~60Hz

Additional NCV Notes

1. Do not touch the tip of the meter to an insulated wire directly if its thickness is > 1.5mm.
2. When the tip of the meter is close to or in contact with a conductor, and a voltage is sensed, the NCV display symbol  changes from white to red, flashes, and adds up to three horizontal bars (depending on strength of detected signal). The beeper also sounds.
3. The display symbol is always shown when the function switch is in the NCV position.
4. The specifications apply only when no additional electromagnetic interference is present.

14.4.12 - Peak Hold Mode

Function	Range	Resolution	Accuracy	Input Protection
Peak Hold (AC V)	600.0 mV	0.1 mV	± (5.0% + 15d)	1000 V RMS (Sine wave)
	6.000 V	0.0001 V		
	60.00 V	0.01 V		
	600.0 V	0.1 V		
	1000 V	1 V		

Additional Peak Hold notes:

- Maximum peak value = 1.414 x input value
- Minimum peak value = -1.414 x input value
- Frequency response: 45Hz to 65Hz
- Accuracy assured from 10 to 100% of range
- Frequency sensitivity: Input is ≥ range × 10%

15. Customer Support

For technical assistance, repair and returns, document downloads, and general information, visit the support site, link below:

<https://support.flir.com>

16. Warranty

16.1 Limited 10-year Warranty

This product is protected by FLIR's Limited 10-Year Warranty. Visit <https://support.flir.com/prodreg> to read the Limited 10-Year Warranty document.

**Website**

<https://www.flir.com>

Customer support

<https://support.flir.com>

Copyright © 2023, Teledyne FLIR Commercial Systems, Inc. All rights reserved worldwide.

Disclaimer

Specifications subject to change without further notice. Models and accessories subject to regional market considerations. License procedures may apply. Products described herein may be subject to US Export Regulations. Please refer to exportquestions@flir.com with any questions.

Release Version:

AA

Language:

en-GB